

NOTES:

1. GLUE AND SCREW ALL JOINTS USING WOOD SCREWS.
2. REMOVE BASE FROM ITEM 11 AND SECURE WITH ITEM 12.
3. ITEMS 14 SHOWN LOADED. FABRICATE FROM 24" LENGTH OF ITEM 14. ROUTE THROUGH ITEMS 8 AND SECURE BY INSERTING GLUED 1/4" DIA DOWEL AND CLAMPING WITH ITEMS 15.

REV		DESCRIPTION	DATE	APPROVED

D

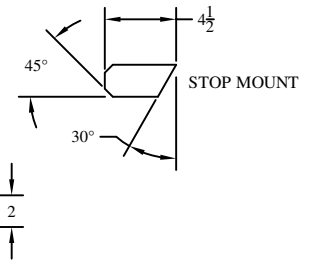
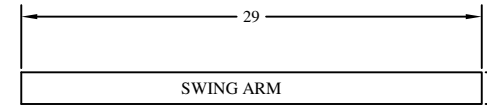
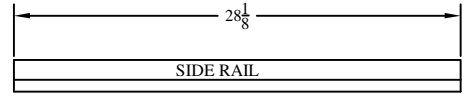
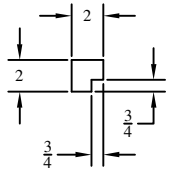
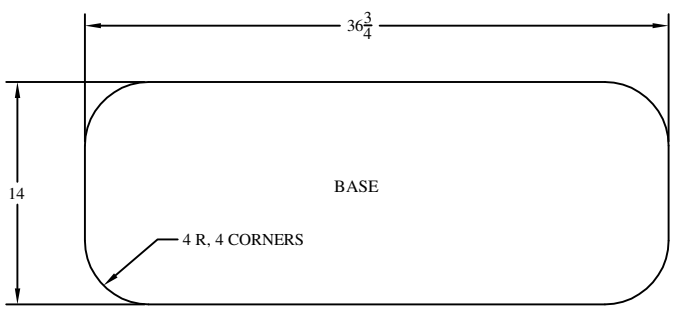

C

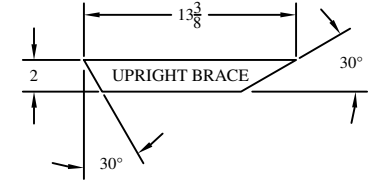
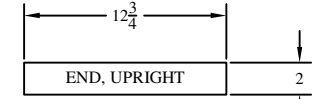
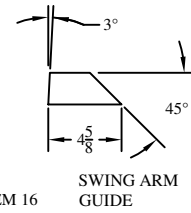

B

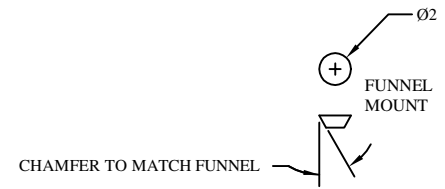
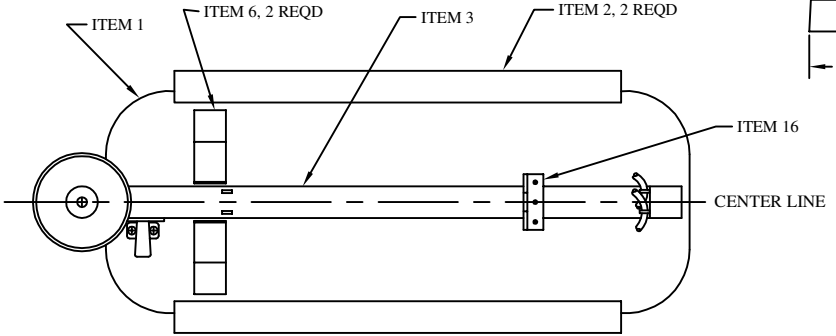

A

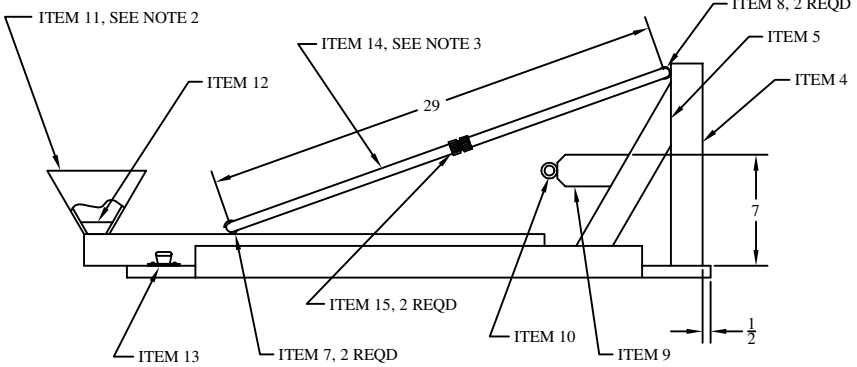

COPYRIGHT © 2001 RCRV and GWAEA

ITEM	QTY	PART NO. OR MATERIAL	NAME
16	1	4" TEE HINGE	HINGE
15	4	HOSE CLAMPS	HOSE RETAINER
14	2	.38 RUBBER HOSE	LAUNCHER
13	1	DOOR LATCH	RETAINER
12	1	3/4 PLYWOOD	FUNNEL MOUNT
11	1	5 1/4 D. FUNNEL	BALL CUP
10	1	1" RUBBER HOSE	STOP
9	1	2X2 PINE	STOP MOUNT
8	2	1/2 I.D. CLSD EYE	RETAINER EYE
7	2	1/2 I.D. OPEN EYE	CATCH EYE
6	2	2X2 PINE	SWING ARM GUIDE
5	1	2X2 PINE	UPRIGHT BRACE
4	1	2X2 PINE	END UPRIGHT
3	1	2X2 PINE	SWING ARM
2	2	2X2 PINE	SIDERAIL
1	1	3/4 PLYWOOD	BASE

BILL OF MATERIAL

This information is circulated as a service to interested persons: no liability is accepted by RCRV in relation to its safety or applicability in individual cases or in relation to its installation or adaption for which appropriate medical, engineering or other professional services ought to be obtained. Permission is hereby given to reproduce this information sheet, drawing or notes. Please give RCRV and the sponsoring organization credit for any information drawings or notes that are disseminated. RCRV is a voluntary organization which provides assistance to disabled people utilizing the capabilities of retired technical volunteers, professional engineers, technicians and tradesmen.

AutoCADt 2000

Rockwell-Collins Retiree Volunteers

THARP THROWER

DESIGNED	DATE	REV	PROJ. NO.	REV
		D	00004	
DRAWN	SCALE	SCALE		
	1/4			

8 7 6 5 4 3 2 1